

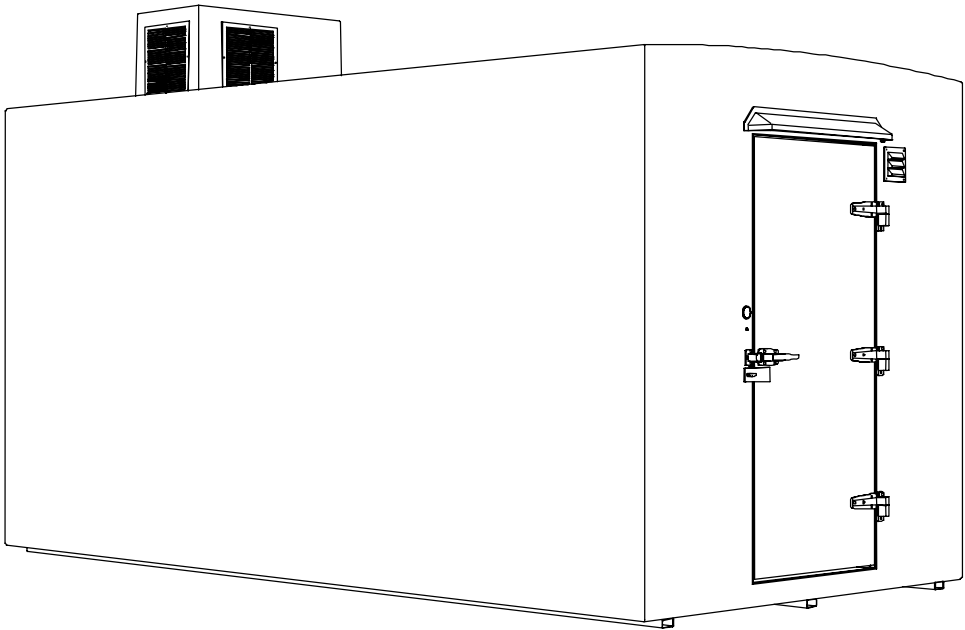

POLAR KING
INTERNATIONAL, INC.

INSTALLATION & SERVICE MANUAL



Seamless Fiberglass Walk-In Coolers and Freezers

4424 New Haven Ave. Fort Wayne, IN 46803
Toll-Free: 800.752.7178 Fax: 260.428.2533
Service: 800.223.2017
www.polarking.com





POLAR KING

INTERNATIONAL, INC.

To Our Customers:

Thank you for purchasing a Polar King® walk-in to fill your refrigerated storage requirements.

Your walk-in has been designed and engineered to provide years of trouble-free service.

All Polar King® walk-ins are factory constructed using space-age materials and state-of-the-art manufacturing techniques. Every unit receives numerous quality inspections and is pre-tested prior to delivery. The finished product is the best and most efficient walk-in available on the market.

However, should you experience a service problem, please contact our customer service department. They will work with you on resolving the problem and insure your continued satisfaction.

Again, thank you for selecting a Polar King®. Should you require future refrigerated storage, we would appreciate the opportunity to serve you.

Polar King® International, Inc.



This manual is also available
online in our resource center.

www.polarking.com



All diagrams are available in larger format online in our resource center at www.polarking.com

Polar King International, Inc. walk-in coolers, walk-in freezers have received the *Industrialized Building Systems (Modular)/Mobile Structures Certification* through the State of Indiana. This certification demonstrates that **Polar King** units meet the requirements set forth by the *State of Indiana Fire and Building Code Enforcement for Class I and Class II structures*.

- Industrialized Building Systems 675IAC15 - 1

This certification program, implemented by the *Fire and Building Code Enforcement Division*, requires that each size specific unit must be inspected at one point during construction as well as an in-plant inspection being performed. Gaining this certification ensures **Polar King** units can be used in both Class I and Class II structures and further demonstrates the quality of the seamless construction methods used to manufacture **Polar King** Walk-In Units.

TABLE OF CONTENTS

REFRIGERATION BASICS	6
HEAT LOAD	6
PRODUCT LOAD	7
LOADING YOUR WALK-IN	7
BASIC STRUCTURE	7
REFRIGERATION	7
INSTALLATION INSTRUCTIONS	8
DO'S	8
DON'TS	8
ROOF FLASHING INSTALLATION	9
SIDEWALL FLASHING INSTALLATION	10
THROUGH WALL DETAILS	11
DOOR OPENING DETAILS	12
TIEDOWN ANCHOR DETAILS	13
BODY HARNESS ANCHOR POINT	14
TOUCHUP PAINT KIT (2-PART)	14
SEQUENCE OF OPERATION: COOLERS AND FREEZERS	15
COOLERS	15
Refrigeration - Initial Start-Up	15
FREEZERS	15
Refrigeration - Initial Start-Up	15
DEFROST	16
(Time Initiated - Temperature Terminated)	16
DEFROST ADJUSTMENTS – Freezer	16
TEMPERATURE ADJUSTMENT USING A421 THERMOSTAT	18
OPERATING TIPS	19
MAINTENANCE	20
RECOMMENDED ANNUAL MAINTENANCE	20
ELECTRICAL	20
CIRCUIT BREAKERS	20
ALLOWABLE VOLTAGES	20
ELECTRICAL CONNECTIONS - SINGLE PHASE	21
Typical Single Phase Wire Connections	21
WIRING INSTRUCTIONS	21
ELECTRICAL CONNECTIONS - THREE PHASE	21
Typical Three Phase Wire Connections	21
WIRING INSTRUCTIONS	21

(Continued on next page)

A General Unit Information Sheet is included with this manual for your convenience. This sheet contains detailed information on your walk-in. Please have this information available when requesting service.

TROUBLESHOOTING	22
GENERAL REFRIGERATION SYSTEM SERVICE ANALYSIS	22
APPROVALS & CODE COMPLIANCES	24
EQUIPMENT APPROVALS / COMPLIANCES	24
CONDITIONS OF SALE	24
PRICES AND TERMS OF PAYMENT	24
DELIVERY	24
POLAR KING® INTERNATIONAL, INC. LIMITED WARRANTY	25
WARRANTY WORK POLICY	26
DATA LOGGING	27

REFRIGERATION BASICS

Modern refrigeration has many applications. The first, and probably the most important, is the preservation of food because most foods kept at room temperature spoil rapidly. However, when kept cold most foods will keep much longer.

Before looking at the operation of mechanical refrigeration, it is important to understand the physical and thermal properties of the mechanisms and substances used to extract heat. Removing heat from the inside of the walk-in is somewhat like removing water from a leaking boat. A sponge may be used to soak up the water and then held over the side, squeezed, and the water released overboard. The operation may be repeated as often as necessary to transfer the water from the boat back into the lake.

In a walk-in, heat instead of water is transferred. Inside the walk-in heat is absorbed by the liquid refrigerant in the evaporator as the refrigerant changes from a liquid to a vapor. After the refrigerant has absorbed heat and turned it into a vapor, it is pumped into the condensing unit located outside the refrigerated space and then compressed. The heat is “squeezed” out by high temperature and then cooled in the condenser. This cycle repeats until the desired temperature is obtained.

Cold is a relative term used to describe low temperature, it is not something that is produced. Rather, the removal of heat results in a condition termed “cold”. A refrigerator produces a condition called “cold” by removing heat from inside the refrigerator and the stored content within it. You have probably felt the heat on the floor as you walked by your refrigerator in your home. The principle of heat removal is the same for your walk-in cooler and/or freezer.

The fact that bacteria are present in most foods calls for it to be preserved in some fashion. Exposing the food to cold or low temperatures slows the growth of these bacteria preventing foods from spoiling as quickly. A cooler temperature slows the activity of all organisms, thus the growth of bacteria on refrigerated food slows dramatically.

The spoiling of food is actually the growth of bacteria. If the bacteria can be kept from increasing, the food will remain edible for a longer period of time. Since most foods contain a considerable amount of water, the food must be kept slightly above freezing temperatures.

If food is frozen slowly, at or near the freezing point of water, large ice crystals will form and break down the food tissues. When such food defrosts, it spoils rapidly and the taste and appearance of the food is greatly compromised. To prevent this problem fast freezing at temperatures between 0°F or below is recommended. By using these low temperatures small crystals form which do not injure the food tissues.

It is always important to keep in mind the difference between refrigerating and freezing. Further, the standard walk-in cooler is designed to maintain the temperature of the product at 35°F, providing the temperature of the product is within 10°F of this temperature. If the product to be maintained is continually at a higher temperature, additional refrigeration system capacity will probably be required. The same parameters hold true for freezers.

HEAT LOAD

As we mentioned earlier, the refrigeration system on your walk-in does not make things cold. The system instead removes heat from the walk-in structure. Where does the heat come from that must be removed by the refrigeration process? The two most common sources you can control are door openings and product load. Did you know that one 100-watt lamp left on in a walk-in would generate 8,208 BTU in a 24-hour period? Keep door openings and closings to a minimum to conserve energy. When working inside the walk-in, close the door behind you. No need to worry, as there is a door opener inside.

PRODUCT LOAD

The main heat load in your walk-in is determined by the amount of heat that must be removed from the stored products. For example, if you load your walk-in with 1,500 pounds of product at 0°F, very little heat will have to be removed to obtain a temperature of -10°F. If the same 1,500 pounds of product is delivered from your supplier at +25°F, you must pay to run the refrigeration system to remove this heat from each and every pound of product, until the satisfactory temperature of -10°F is reached. You will have smaller utility bills if you let your supplier remove heat from the product, rather than doing it yourself.

Remember, your unit is designed as either a holding unit (little or no product load) or has been designed to compensate for known product load. It is important that your walk-in is designed to match your product load and how you will use it. If significant product load occurs in a unit designed for holding, serious temperature problems may occur.

LOADING YOUR WALK-IN

Always move product into your walk-in as soon as you receive it. The longer you wait the more heat it will absorb and the more you will pay to operate the walk-in. As you load your walk-in, be sure to allow plenty of airflow around the product because good airflow decreases the amount of time needed to remove heat. Be sure to allow adequate room around the evaporator. As well, never have a product closer than 12 to 16 inches from the evaporator. Remember, the evaporator is hot during defrost and can thaw a product that is too close.

BASIC STRUCTURE

The structure of your walk-in is manufactured at our factory in Fort Wayne, Indiana. Four-inch, five-inch, or six-inch, two-pound density foam insulation (the most efficient insulation available) is used in the walls, floor, and ceiling of the unit. The base of the unit has a built-in steel frame providing tremendous strength and allows for easy movement or total portability should your needs require this flexibility.

The unit is completely encased in fiberglass...one continuous surface...which means no seams, no rivet holes, and no air leaks. Unlike other outdoor units, you will never have to caulk splits or metal tears in your Polar King® walk-in. No protective roofs or enclosures are required. You won't pay to "cool the outside" with a Polar King® unit. All the cold air stays in the unit where it belongs. This equates to big dollar savings for you.

REFRIGERATION

Polar King® selects the best refrigeration components available for each walk-in application.

Every system is engineered to provide maximum operating efficiency and years of trouble-free operation. All units are adjusted to the customer's temperature requirements. Trained technicians test and monitor the performance of each unit for 24 hours prior to it leaving our factory.

INSTALLATION INSTRUCTIONS

Polar King® walk-in coolers and/or freezers are delivered to our customers fully assembled and require only a few basic procedures prior to start-up.

DO'S

1. Provide a level slab as required by your local building code. It is very important that the surface is level for proper drainage and operation.
2. Condensing unit on the top (or back) of the walk-in should be a minimum of 6 feet from any building intake or exhaust ventilation fans.
3. Keep an open area of at least 3 feet around condensing unit to assure that sufficient air ventilates across the compressor.
4. Make sure you have adequate electrical service for your particular unit.
5. Once walk-in is in place, a qualified electrician in accordance with the NEC and/or local electrical codes may then wire it. A wiring diagram is located on the back of the electrical box panel on the condensing unit.
6. Loosen compressor-mounting bolts (if supplied).
7. Set the correct time of day on the defrost timer. This is necessary in order for the preset defrost to occur at the desired times.
8. If unit is delivered or sits idle in winter months, an external heat source should be applied to the compressor crankcase for 12 to 24 hours prior to start-up.
9. The unit is now ready for operation. (See sequence of operation.)
10. Units are preset at the factory to automatically include four defrost cycles with a minimum duration of 30 minutes each. Preset defrost cycles may be changed to accommodate different applications.

DON'TS

1. Do not physically alter any controls, switches, wires or any device carrying an electrical current, without disconnecting power to the walk-in cooler and/or freezer.
2. The box temperature is preset at the factory to customer request. Temperature selection should not be adjusted up or down. If a different temperature is required, contact Polar King® for proper procedure on changing the preset temperature.
3. When cleaning the inside of the unit with any liquid substance, turn off electrical power.
IMPORTANT: DO NOT USE BLEACH OR AMMONIA TO CLEAN INSIDE OF UNIT AS IT MAY CAUSE DAMAGE TO THE EVAPORATOR COIL ALUMINUM FINNS.
4. **IMPORTANT: DO NOT DISCONNECT MAIN POWER SUPPLY WHILE COMPRESSOR IS RUNNING. DAMAGE MAY OCCUR AT RESTART IF COMPRESSOR IS NOT ALLOWED TO PUMP DOWN.**

ROOF FLASHING INSTALLATION

1. Read instructions thoroughly before starting. Take inventory of necessary materials. Items provided by Polar King® include:
 - a. 12" Self-adhesive Elastoform flashing. (The adhesive side has a plastic film covering that should be removed prior to installation and the back side is uncovered.)
 - b. 45° cant strip (fillet strip).
 - c. Pre-drilled aluminum termination bar.
2. Additional items needed:
 - a. Mechanical fasteners (screws or other type of fastener) for termination bar.
 - b. Silicone sealant.
3. See Flashing Detail for approximate placement of materials.
4. Using mineral spirits, clean roof of walk-in and adjoining wall to a distance of 12".
5. Place cant strips against building as shown on detail.
6. Place flashing face up onto the cleaned area of the roof and wall, while keeping it centered on the cant strip.
7. Apply pressure to the flashing to be sure that there is a good bond against the roof and the wall.
8. Install supplied termination bar over top edge of Elastoform flashing. Fasten approximately 12" on center. (Fasteners are not included.)
9. Apply bead of silicone sealant (not included) to top of termination bar to finish installation. The completed flashing assembly can be painted if desired.

ROOF FLASHING DETAIL

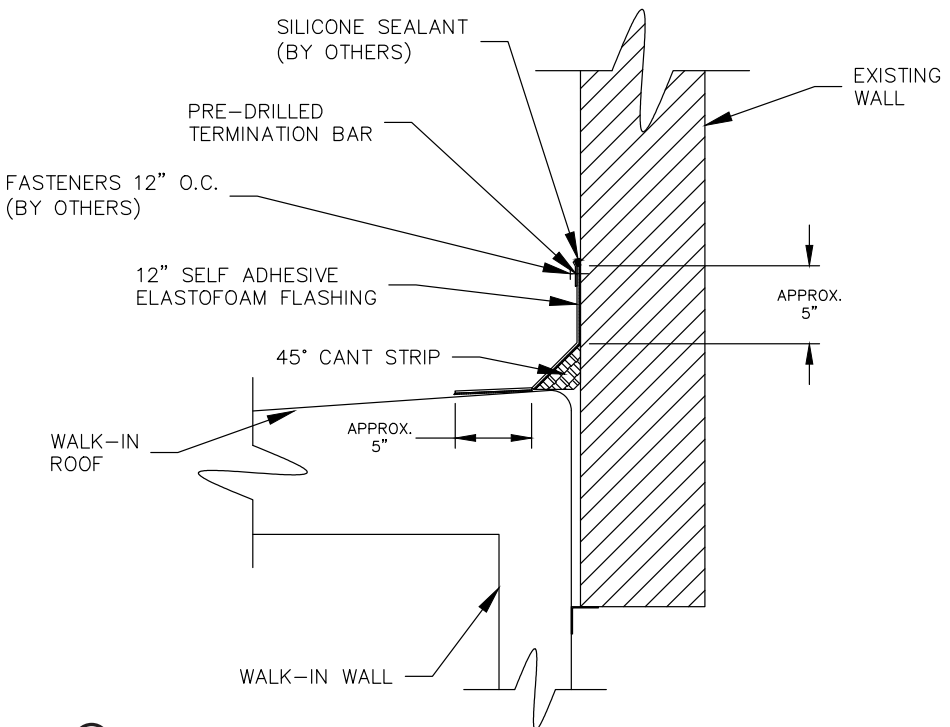

All diagrams are available in larger format online in our resource center at www.polarparking.com

SIDEWALL FLASHING INSTALLATION

1. Read instructions thoroughly before starting. Take inventory of necessary materials. Items provided by Polar King® include:
 - a. PVC flashing (1" x 5" L-shape PVC material).
2. Additional items needed:
 - a. Mechanical fasteners (screws or rivets).
 - b. Construction adhesive.
 - c. Silicone sealant.
3. Align PVC flashing against building and walk-in and trim for proper fit. Flashing may be applied with short leg sticking out or in.
4. Flashing can be attached to walk-in using any heavy-duty construction adhesive.
5. Use sheet metal screws to hold in place until adhesive sets.
6. Apply bead of silicone sealant to finish installation.

PROVIDE A LEVEL SLAB AS REQUIRED BY YOUR LOCAL BUILDING CODE.

NOTE: It is very important that the surface the walk-in will sit on is level and flat for proper drainage and mechanical operation.

THROUGH WALL DETAILS

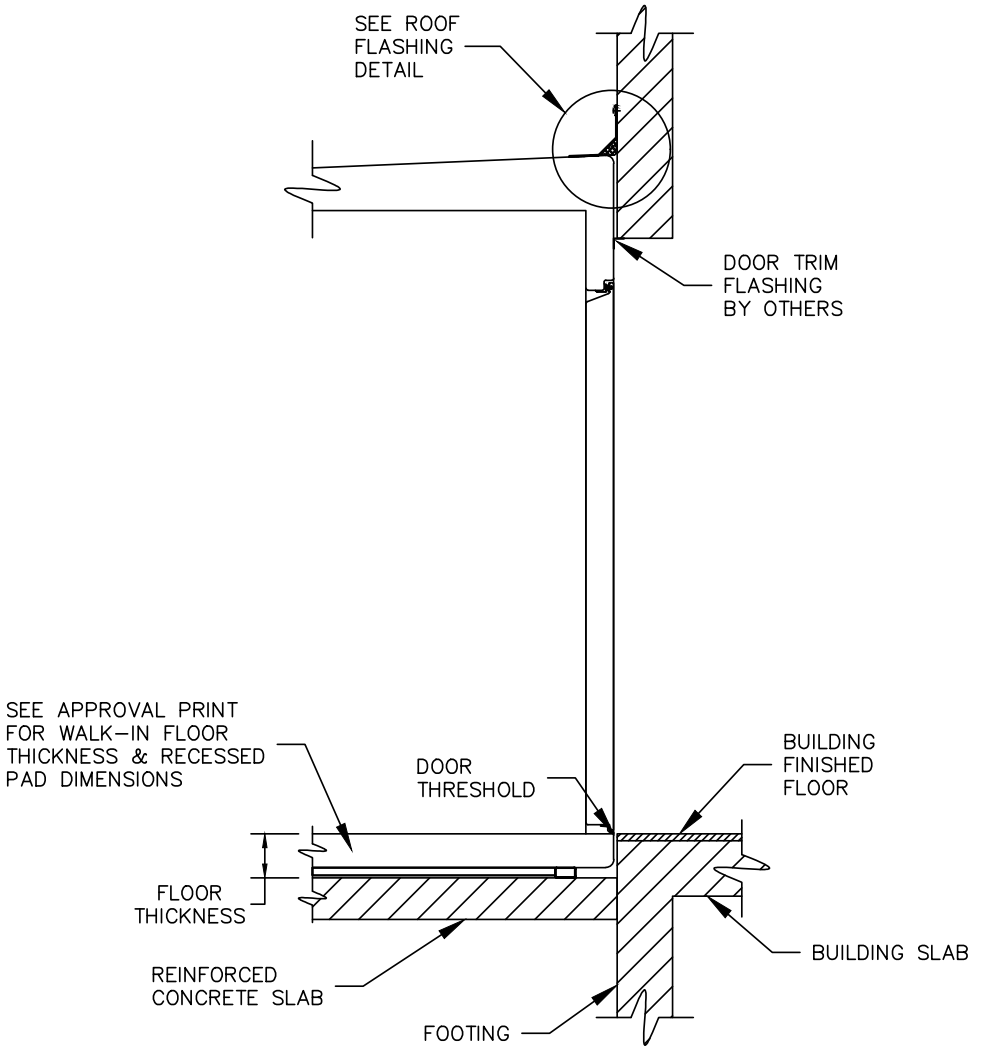

All diagrams are available in larger format online in our resource center at www.polarking.com

DOOR OPENING DETAILS

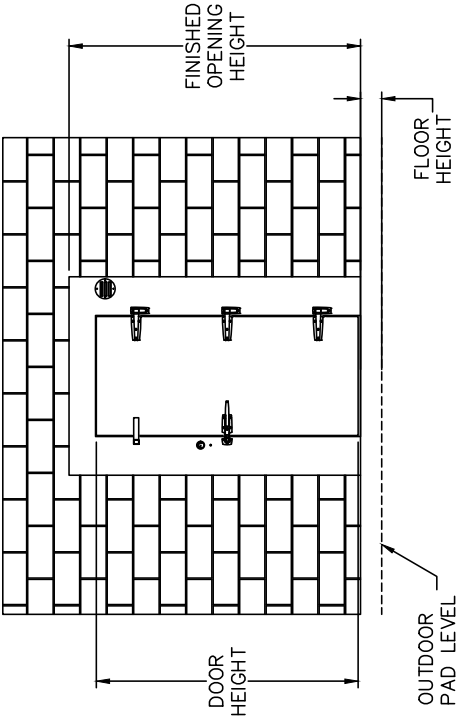

HEIGHT OF OPENING TO BE MINIMUM 8"
GREATER THAN DOOR HEIGHT
(SEE APPROVAL PRINT FOR DOOR DIMENSIONS)

DOOR HEIGHT	FINISHED OPENING HEIGHT
24"	32"
36"	44"
72"	80"
79"	86"

(HEIGHT OF OPENING TO BE APPROXIMATELY
8" GREATER THAN DOOR HEIGHT)

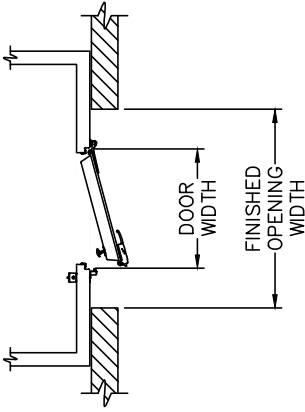

RECOMMENDED MINIMUM OF 12" ON BOTH
SIDES OF DOORS
(SEE APPROVAL PRINT FOR DOOR DIMENSIONS)

*FINISHED OPENING WIDTH TO BE LARGER IF TEMPERATURE
MONITORS OR OTHER EQUIPMENT IS TO BE MOUNTED
ON THE LATCH SIDE OF THE DOOR.

DOOR WIDTH	FINISHED OPENING WIDTH
24"	48"
30"	54"
36"	60"
48"	72"



All diagrams are available in larger format online in our resource center at www.polarking.com

TIEDOWN ANCHOR DETAILS

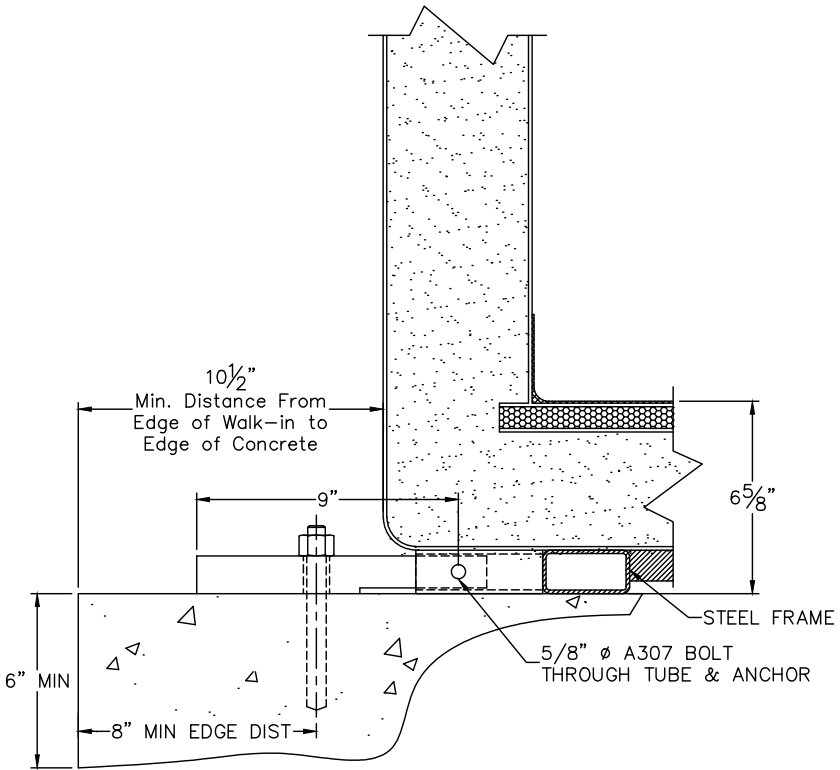

CONCRETE FOUNDATION (BY OTHERS)
 $f'_c = 4000$ PSI
FOUNDATION DESIGN FOR 964 LB (SHEAR) AND
0 LB (TENSION) @ ANCHOR LOCATION

*USE 5/8" ϕ HILTI KB-TZ SS 304
W/ 3-9/16" EMB.

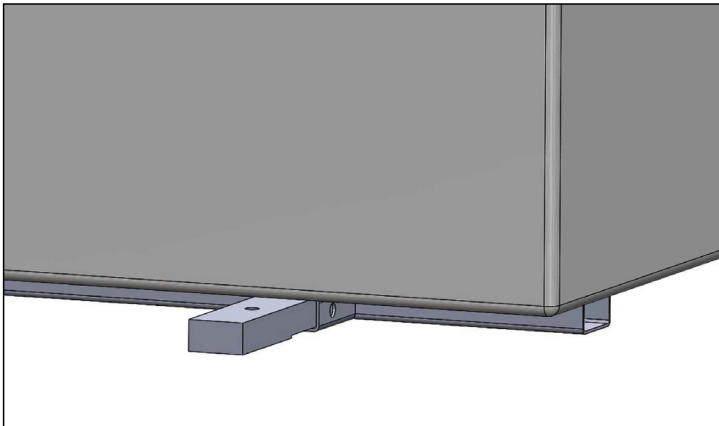

BODY HARNESS ANCHOR POINT

When performing maintenance or other work on top of the unit, a Body Harness Anchor Point is included with every Polar King Walk-In Unit. The body harness anchor point is intended for fall protection and is rated to a pullout strength of 5,000 lbs.

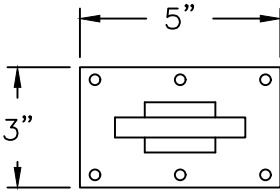

(6) 3/8"x1" LAG BOLTS
ASSUMING 625 Lbf PULLOUT PER BOLT
= 5,000 Lbf AVAILABLE SHOCK LOAD

D-RING RATED FOR 12,000 Lbf
WELDED TO 3/16" A36 STEEL PLATE

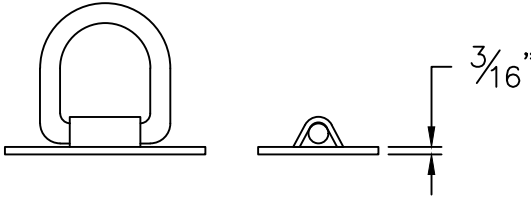

TOUCHUP PAINT KIT (2-PART)

Contents of Box Provided by Polar King:

- 1 pint of paint
- 8 oz hardener
- 4 oz thinner

What You Will Need:

- Small bucket or can to mix paint
- Safety glasses and gloves
- Paint mixer or wooden stirring paddle

Note: Be sure to wear both safety glasses and gloves while mixing paint.

Instructions for Mixing Touchup Paint:

Both paint hardener and paint thinner have been premeasured. Ensure you use all contents of each. **Do Not** add any additional paint or thinner.

In a small bucket or can, pour in the paint. Slowly mix in the hardener and thinner. Using a paint mixer or wooden stirring paddle, carefully mix the components together scraping both the sides and bottom.

Note: These items must be properly mixed in order to get the desired color and for the paint to dry properly.

SEQUENCE OF OPERATION: COOLERS AND FREEZERS

COOLERS

All standard units are equipped with an adjustable thermostat located on the inside of the walk-in. All units are set at the factory to the temperature requested by the customer. Minor adjustments in operating temperature may be made to suit your needs. Polar King® recommends that you do not set the temperature colder than required, as this will cause unnecessary power consumption. Recommended temperature for a cooler ranges from +34°F to +37°F, unless specified otherwise, for special applications.

Refrigeration - Initial Start-Up

When starting up the cooler refrigeration system for the first time, the following events occur.

The operating sequence is as follows:

1. Thermostat calls for refrigerant.
2. Liquid line solenoid valve opens, allowing refrigerant to flow.
3. Pressure control makes the control circuit and the condensing unit operates.
4. When the room thermostat is satisfied, the liquid line solenoid will close, and the compressor will pump down and turn off. (Fan on unit cooler will continue to run.)

These units are designed for application conditions 34°F and above.

CAUTION: DO NOT SET A COOLER BELOW 32°F OR DAMAGE MAY OCCUR.

FREEZERS

All standard units are equipped with an adjustable thermostat located on the inside of the walk-in. All units are set at the factory to the temperature requested by the customer. Minor adjustments in operating temperature may be made to suit your needs. Polar King® recommends that you do not set the walk-in temperature colder than required, as this will cause unnecessary power consumption. Recommended temperature on a freezer ranges from 0°F to -10°F for frozen food, and -10°F to -15°F for ice cream.

Refrigeration - Initial Start-Up

When starting the system up for the first time, the fans will be delayed by the defrost termination thermostat and will not operate until the coil temperature is approximately +20°F.

The operating sequence is as follows:

1. Thermostat calls for refrigerant.
2. Liquid line solenoid valve opens, allowing refrigerant to flow.
3. Pressure control makes the control circuit and the condensing unit operates.
4. The coil temperature falls to approximately 20°F and the evaporator fans come on.

NOTE: The fans may cycle two or three times until the room temperature is stabilized.)

5. When the room thermostat is satisfied, the liquid line solenoid will close, and the compressor will pump down and turn off. (Fan on unit cooler will continue to run.)

Defrost

(Time Initiated - Temperature Terminated)

After a run period of approximately 6 hours, the evaporator coil will be frosted and require a defrost cycle. Four defrost cycles per day are programmed at the factory (4 a.m., 10 a.m., 4 p.m., and 10 p.m.). It may be necessary to change the defrost cycle times to fit your work schedule.

The interior temperature may rise 10°F to 20°F during the defrost cycle. Do not be alarmed. No thawing of the product will occur. Soon after the cycle is complete, the unit will return to operating temperature.

The defrost sequence is as follows:

1. Timer starts defrost cycle.
2. Liquid line solenoid valve closes, evaporator fans stop, and the defrost heaters are energized.
3. After pumping down, the compressor stops.
4. The heaters warm the coil, melt the frost, and trip the termination thermostat at the set temperature.
5. The defrost cycle is terminated, the liquid line solenoid opens, and defrost heaters are de-energized.
6. The pressure switch closes and the compressor starts the refrigeration cycle.
7. The evaporator fans will remain off until the coil temperature reaches approximately 20°F.

Should the termination thermostat fail to end the defrost cycle, the timer fail-safe time is designed to end after 30 minutes.

Defrost Adjustments – Freezer

Optimal defrost is accomplished when the defrost cycle ends immediately after all the ice has cleared from the finned coil surface on the evaporator. Too short or too long of a defrost period may cause operational problems or waste electricity.

The defrost periods set at the factory are for “average” freezer use. Depending on the frequency of door openings and the ambient climate, it may be necessary to make adjustments to the defrost cycle.

- **ICE DROPLETS FORMING ON THE CEILING** is a sign that the system is remaining in defrost too long after the ice clears from the coil fins. This can be corrected by shortening the defrost duration.

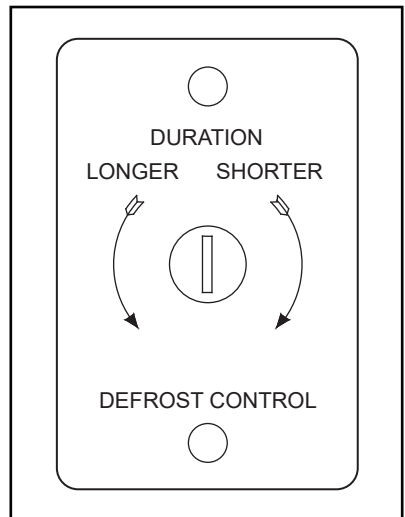

If freezer still remains in defrost too long, a defrost setting pin should be removed from the timer clock. Repeat if necessary.

- **ICE BUILD-UP ON BACK OF EVAPORATOR COIL** is a sign that the defrost period is not long enough. Turn duration setting towards the “longer” position. If build-up still occurs, a defrost setting should be added to the timer clock.

NOTE:

1. If excessive ice build-up has occurred, it may be necessary to manually melt away ice from coil surface prior to making adjustments. System must be turned off in order to manually defrost the coil.
2. Allow 24 hours between adjustments.
3. Not all freezers are adjustable. To find out if yours is, call for assistance.

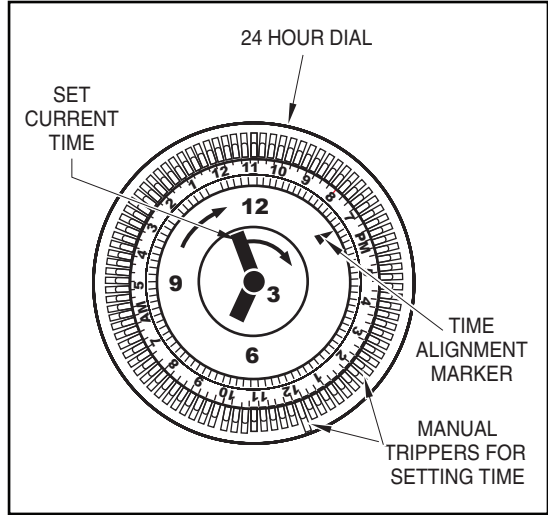

TEMPERATURE ADJUSTMENT USING A421 THERMOSTAT

To adjust temperature on your A421 thermostat:

1. Press MENU button.
 - a. "OFF" will be displayed.
2. Press MENU button again.
 - a. The temperature the compressor will turn OFF will be displayed.
 - b. Adjust the up or down arrow key to the desired room temperature.
3. Press MENU button.
 - a. "ON" will be displayed.
4. Press MENU button again.
 - a. The temperature the compressor will turn ON will be displayed.
 - b. Adjust the up or down arrow key to a temperature a few degrees warmer than the desired room temperature.

NOTE: A "SNOWFLAKE" **MUST** appear in the lower right corner of the display, indicating the system is in REFRIGERATION MODE. If a "FLAME" appears, the "OFF/ON" temperatures need to be reversed.

5. Press the MENU button again to save the settings. When "SF" appears, leave controller alone and after 30 seconds it will revert back to the room temperature.

For the refrigeration cycle to work properly, the OFF temperature must be set lower than the ON temperature. For example, if you desire a 0°F room temperature, set the OFF temperature to 0°F and the ON temperature to +3°F. With these settings, the refrigeration cycle will start when the temperature is 3°F or above, and will end when the room temperature is 0°F.

For more detailed instructions, you may scan the Quick Response (QR) Code on the face of the thermostat.



OPERATING TIPS

The operation of your Polar King® walk-in cooler and/or freezer has been engineered to be as simple and trouble free as possible. This manual provides you some helpful hints for everyday use of your equipment.

1. After unit has been delivered, we recommend that anyone who will work with your Polar King® unit should take a minute and walk through it to familiarize themselves with the unit.

THINGS TO LOOK FOR:

- A. Door Handle: Locking equipment and safety equipment.
 - B. Lighting: Location of switch, indicator light, and light bulb.
 - C. Thermometer: Proper operating temperature. If the temperature displayed on the thermometer is incorrect, the thermometer may be out of adjustment. Verify the walk-in temperature with another thermometer.
 - D. Thermostat: Located on right side of evaporator coil in unit. Adjusting dial higher or lower can change the temperature. Polar King® recommends that you do not run your unit any cooler than required for economical operation. (Do not set a cooler 32°F or below or damage may occur.)
2. Keep door opening and closing to a minimum to conserve energy.
 3. When working inside, close the door behind you. There is a door opener inside.
 4. When loading unit, be careful not to block the airflow from coil.
 5. Periodically check coil fan for proper operation. Check coil for ice. Faulty fan or iced coil will cost you unneeded power use.

MAINTENANCE

RECOMMENDED ANNUAL MAINTENANCE

As part of a comprehensive maintenance plan, Polar King® recommends that the following service functions be performed at least once a year. (Heavy dust areas may require more frequent attention). It is also recommended that a qualified refrigeration technician perform this service.

1. Clean condenser coil.
2. Check unit for proper operation.
3. Check refrigerant charge.
4. Have condensate drain line checked and cleaned.
5. Have evaporator coil checked and cleaned with mild detergent.
6. Oil all electric motors in use.
7. Check cut-in and cut-out pressures.
8. Check for proper defrost cycle.
9. Check caulking around drain lines and any other through wall and roof penetrations. Reseal as necessary.

ELECTRICAL

CIRCUIT BREAKERS

All Polar King® coolers and freezers are equipped with circuit breakers. Circuit breakers must be in the "ON" position for the unit to operate.

DO NOT USE THE CIRCUIT BREAKERS AS AN ON-OFF SWITCH. Units must go through a "pump down" first or compressor damage may occur at start up.

Interior lights are prewired. No special connections are required; they are activated when system connections are made.

ALLOWABLE VOLTAGES

EXTREME ALLOWABLE VOLTAGE AT COMPRESSOR TERMINALS

	Nominal Voltage Range	Extreme Voltage Range
Single Phase – 60 HZ	230	207-253
Three Phase – 60 HZ	208-230	187-253
	460	414-506
	575	518-632

ELECTRICAL CONNECTIONS - SINGLE or THREE PHASE

WIRING INSTRUCTIONS

Control Panel is located at the condensing unit on top of the walk-in.

A hole may be drilled through the fiberglass condensing unit cover for incoming power.

Electrical hookup must comply with the National Electrical Code.

The installed control panel may or may not have a circuit breaker holder installed.

TROUBLESHOOTING

GENERAL REFRIGERATION SYSTEM SERVICE ANALYSIS

PROBLEM	POSSIBLE CAUSES	CORRECTIVE STEPS
Compressor will not run.	No supply at motor.	Check connections and controls.
	Main disconnects open	Close disconnect.
	Fuse blown	Repair electrical defect; replace fuse.
	Overload open circuit	Rectify overload condition; replace overload.
	Control open circuit.	Repair or replace.
	Burn out.	Check windings with meter.
Compressor hums but will not start.	Incorrectly wired.	Check against wiring diagram.
	Motor winding incorrectly connected.	Check winding resistance. The resistance of the start windings for single-phase motor should be higher than that of the run windings. The windings of three-phase motors should be equal.
	Low line voltage.	Check voltage at motor terminals.
	Start capacitor open circuit.	Replace start capacitor.
	Relay not operating.	Replace relay.
	Motor winding open circuit.	Check leads; if correct, replace compressor.
	Seized compressor.	Check oil level; rectify seize or replace compressor.
	Piston jammed or broken valve reed.	Rectify cause of liquid pumping; replace valve plate.
Compressor will not run up to speed.	Low line voltage.	Check voltage at motor terminals.
	Relay defective.	Replace relay.
	Start capacitor shorted.	Replace capacitor.
	High discharge pressure.	Ensure that discharge shut-off valve is open. Check condenser cooling.
	Incorrectly wired.	Check against wiring diagram.
	Motor winding incorrectly connected.	Check winding resistance. The resistance of the start windings for single-phase motors should be higher.
Compressor short cycles.	Control differential too small.	Readjust controls.
	Valve plate leaking.	Replace valve plate.
	Motor overloading.	Check condenser cooling, refrigerant charge, compressor lubrication, and load conditions.
	Shortage of refrigerant.	Repair leak and check for acidity.
	Expansion valve.	Adjust or replace.
	High-pressure switch operates.	Check condenser cooling, and refrigerant charge.

PROBLEM	POSSIBLE CAUSES	CORRECTIVE STEPS
Start relay burnt out.	Low voltage.	Check voltage at motor terminals.
	Run capacitor incorrect.	Fit correct valve capacitor.
	Short cycling.	Reduce number of starts per hour to 20 or less.
	Prolonged operations on start windings.	Reduce starting load, check for low voltage.
	Incorrect relay.	Fit correct relay.
High discharge pressure.	Refrigerant overcharge.	Remove refrigerant.
	Air in system.	Purge air.
	Dirty condenser.	Clean condenser.
Low discharge pressure.	Shortage of refrigerant.	Check for leaks and moisture; add refrigerant.
	Compressor inefficient.	Check and replace valve plate.
Compressor noisy.	Shortage of oil.	Check application for oil return; add oil.
	Pumping liquid.	Check application for oil return; ensure that liquid refrigerant does not return to compressor.
	Broken valve reed.	Check application for liquid pumping; replace valve plate.

APPROVALS & CODE COMPLIANCES

EQUIPMENT APPROVALS / COMPLIANCES

National Sanitation Foundation (NSF)

U.L. Listed, Class I Foam Insulation

U.L. Listed Major Refrigeration Components

Miami-Dade Approved (NOA #18-0516.05)

CONDITIONS OF SALE

All sales of goods by Polar King® International, Inc., or through its designated representatives (hereinafter referred to as "The Seller") are made subject to the terms and conditions appearing herein.

CONDITIONS OF SALE

Acceptances of orders from buyers are subject to acceptance by the Seller at its Ft. Wayne, Indiana plant. These conditions of sale shall govern and control all orders accepted by Polar King® or its representatives. No terms or conditions appearing in the buyer's order that are contrary to the Seller's terms and conditions shall be binding upon the Seller unless specifically agreed to in writing by an officer of Polar King®. No representative or agent shall have the authority to abrogate or change any part of these conditions of sale, nor to obligate the company for costs of any kind whatsoever, without permission from an officer of Polar King®.

PRICES AND TERMS OF PAYMENT

Prices - The manufacturer's suggested list price is subject to change without notice.

Terms of Payment - Unless other terms are specified, payment shall become due 30 days from date of invoice. If shipment is delayed by the buyer, date of readiness for shipment shall be determined by the purchase price and percentage of completion of the order; the balance shall be payable within 30 days from date of invoice or readiness for shipment, as the case may be. All accounts not paid when due are subject to a service charge of 1-1/2% per month. If, in the Seller's judgment, the buyer's financial condition at any time does not justify the terms specified, the Seller may require full or partial payment as a condition to commencing or continuing manufacture or advance of shipment, or if shipment has been made, recover equipment from the carrier.

Taxes - Any tax or other governmental charge now or hereafter levied upon the production, sale, use or shipment of goods ordered or sold will be charged to and paid for by the buyer. Such taxes are not covered in the Seller's price unless expressly so stated on the quotation form.

Freight - Prices are F.O.B. shipping point unless otherwise quoted in writing.

DELIVERY

All delivery dates given by the Seller are approximate and are estimates only not promises and are contingent of fires, strikes, accidents, embargoes and other causes beyond the Seller's control. While every effort will be made to meet estimated delivery dates, the Seller accepts no liability for loss of profit, consequential, or other damages caused by delay in delivery or failure to deliver. The Seller has no obligation to deliver goods against any order unless and until it has accepted the order by issuance of its acknowledgment of order. The Seller assumes no responsibility beyond delivery to carrier in good order and is not responsible for loss, damage, goods in transit, or in aiding the purchaser in case of loss or damage. The consignee should make all claims for loss, damage, or delay against the carrier.

POLAR KING® INTERNATIONAL, INC. LIMITED WARRANTY

Polar King® International, Inc. hereinafter referred to as Polar King®, warrants that walk-in coolers and freezers manufactured by the company are free from any defect in both materials and workmanship under conditions of normal use and service. The obligation of the manufacturer under this warranty shall be limited to the conditions described below. This warranty is not assignable without the express consent of Polar King® and applies to the original purchaser of walk-in units installed and operated within the contiguous United States.

A. 25 Year Limited Insulation Material Warranty (Seamless Fiberglass Walk-in Units)

On units originally purchased from Polar King®, Polar King® warrants the internal foam insulation for walk-in coolers and freezers to be free of defects in both the materials and workmanship for a period of twenty-five (25) years from the date of delivery of the unit. This warranty covers only the replacement materials and labor.

B. 12 Year Limited Structural Warranty (Seamless Fiberglass Walk-in Units)

On units originally purchased from Polar King®, Polar King® warrants the structural integrity for walk-in coolers and freezers for a period of twelve (12) years from the date of delivery of the unit. This covers the structure, roof, doors, interior and exterior surfaces and frame to be free of both defects in material and workmanship. This warranty covers only the replacement materials and labor.

C. 1 Year Limited Refrigeration System and Components Warranty (Seamless Fiberglass Walk-in Units)

On units originally purchased from Polar King®, Polar King® warrants the refrigeration system and components for walk-in coolers and freezers for the period of one (1) year from the date of delivery of the unit. This covers the refrigeration system, motors, compressors, condensers, evaporators, safety and operations controls, electrical components, defrost system, refrigerant specialties, and piping to be free of both defects in material and workmanship. This warranty covers only replacement materials and labor.

D. 4 Year Extended Limited Compressor Warranty

On units originally purchased from Polar King®, Polar King® warrants the compressor for an extended additional period of four (4) years after the expiration of the general compressor warranty contained in Paragraph C above. This covers the compressor to be free of defects in materials and workmanship. This extended additional warranty shall be limited to replacement of the compressor by Polar King®. The Polar King® obligation to pay for replacement shall never exceed the wholesale exchanged price for a like compressor that might be purchased locally. This extended additional warranty does not cover or include any cost or expense for refrigerant or labor.

E. 1 Year Limited Miscellaneous Parts and Accessory Items Warranty

On units originally purchased from Polar King®, Polar King® warrants all miscellaneous parts and accessory items for walk-in coolers and freezers for the period of one (1) year from the date of delivery of the unit. This covers all miscellaneous parts and accessory items not manufactured by Polar King®, but which were attached or otherwise installed by Polar King® at the customer's request, to be free of defects in materials and workmanship. This warranty covers replacement materials and labor only.

NOTE: *This warranty is in lieu of all other warranties expressed or implied and does not apply to equipment, damage, or malfunctions attributed to normal wear and tear, accidents, improper installation, abuse, misuse, flood, fire, war, nuclear contamination, improper and/or unauthorized repairs, negligence, or any casualty unforeseen other than an operating defect or failure within the warranty period. Polar King's obligation hereunder shall be limited to the current Polar King® cost to repair or replace any item. In no event shall Polar King® be liable for any direct, indirect, or consequential damages for loss due to the defects warranted including, but not limited to, the loss of contents stored within the unit, or lost profits or revenues. This warranty does not cover any products installed outside of the contiguous United States.*

All warranty service claims made must be made in accordance with the Polar King® "Warranty Work Policy" located on the following page.

WARRANTY WORK POLICY

In the event of a defective part or malfunction in operation of your Polar King® walk-in cooler and/or freezer, the following steps must be taken to ensure successful warranty coverage.

1. Review Preliminary Checklist

A. Check the power source to your walk-in cooler and/or freezer. Make certain that the unit is correctly powered on and the power source is on. Check any breaker box or the external power supply.

B. Check the bottom of the evaporator coil. Note if there is heat on the bottom of evaporator coil in the walk-in. If this is the case, the unit may be in a defrost cycle. Wait for approximately 30 minutes. If the unit is in a defrost cycle, it should return to proper operation after cycle is completed.

C. Check to see if the thermometer is working properly. If possible, use a secondary thermometer to check the internal temperature of the unit.

After this checklist has been reviewed and operation has not been restored, the following steps must be taken to initiate warranty service and to prevent product damage:

A. Contact the licensed commercial refrigeration company of your choice or contact Polar King® for a recommendation on a local service company.

B. If your Polar King® unit is a cooler, standard ice should be packed around food or other products, in order to maintain proper temperature. Additionally, if possible, limit the number of times the doors are opened as well as the duration of time open.

C. If your Polar King® unit is a freezer, it is very important to limit the number of times the doors are opened as well as the duration of time open. Additionally, do not introduce heat into the freezer and contact a service provider as soon as possible.

D. After problem has been identified by your service provider, have them contact Polar King® for warranty authorization and a work order number.

E. If a problem occurs outside of normal business hours (8 A.M. - 5 P.M. EST) have your service company correct problem and call Polar King the following day to obtain a work order number.

F. All replaced parts and the repair bill must be sent to Polar King® International, Inc. (4424 New Haven Avenue, Fort Wayne, IN 46803) freight collect.

All steps and procedures stated in this "Warranty Work Policy" must be followed precisely. Failure to follow the "Warranty Work Policy" may make you responsible for all expenses incurred, since any service call not requiring warrantable item will not be paid for by Polar King® International, Inc. This warranty is not assignable without the express consent of Polar King® and applies to the original purchaser of walk-in units installed and operated within the contiguous United States.

NO WARRANTY CLAIM WILL BE PAID WITHOUT A WORK ORDER NUMBER ON THE INVOICE AND THE REPLACED PARTS RETURNED TO POLAR KING® INTERNATIONAL, INC.

TO OBTAIN WARRANTY SERVICE AUTHORIZATION PLEASE CALL:

800.223.2017

4424 New Haven Ave. Fort Wayne, IN 46803
Toll-Free: 800.752.7178 Fax: 260.428.2533

www.polarking.com

DATA LOGGING

Serial # _____

Start Date: _____ Start Time: _____

Employee: _____

Shut Down Date: _____ Shut Down Time: _____

Employee: _____



POLAR KING
INTERNATIONAL, INC.

SEAMLESS FIBERGLASS WALK-IN COOLERS & FREEZERS

4424 New Haven Ave. Fort Wayne, IN 46803

Toll-Free: 800.752.7178 Fax: 260.428.2533

Service: 800.223.2017

www.polarking.com

