

ROOM TEMP.:
Dry
 INTERIOR AREA:
50 sq. ft.
 HORSEPOWER:
—
 REFRIGERANT:
—
 ELEC. SUPPLY
115
 PHASE:
Single
 CYCLE:
60 hz.
 AMPERAGE:
1.0 MCA

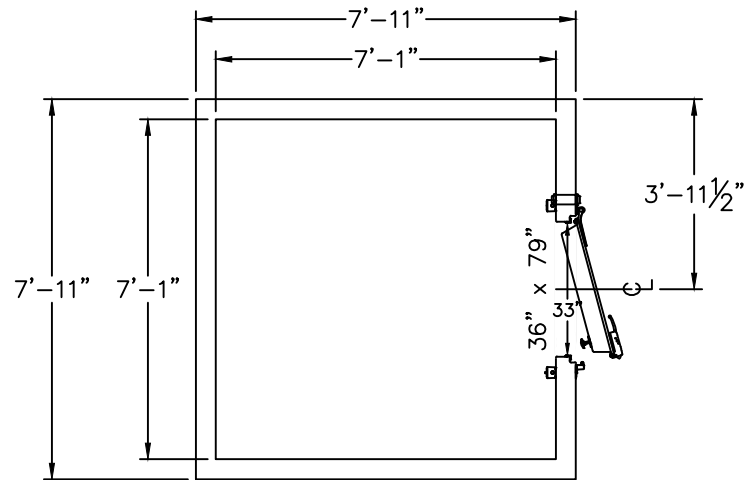

PLAN VIEW

SERIAL NUMBER: A13056816

5" WALLS
 5" CROWNED ROOF
 1/2" STANDARD DUTY FLOOR

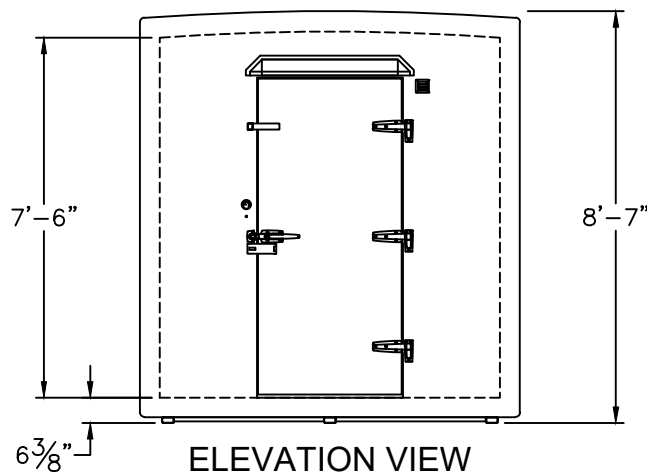

ELEVATION VIEW

DRAWING APPROVAL

PLEASE INDICATE YOUR APPROVAL OF THIS DESIGN, THE DIMENSIONS, DOOR LOCATION/SWING, ELECTRICAL REQUIREMENTS, AND EQUIPMENT LOCATIONS BY SIGNING BELOW AND RETURNING TO POLAR KING.

DATE: _____ BY: _____

A13056816

DRAWN BY: RLM	MODEL NO.: D88	SCALE: 1/4" = 1'	DATE: 1/8/21
------------------	-------------------	---------------------	-----------------

DRAWING NAME: A13056816 D88



POLAR KING
 INTERNATIONAL, INC.
 FORT WAYNE, INDIANA 1-800-752-7178

THE REFRIGERATION SYSTEM SHOWN IS DESIGNED TO MAINTAIN INDICATED TEMPERATURE IF PRODUCT ENTERS WITHIN 10°F OF FINAL HOLDING TEMPERATURE. PLEASE CONTACT YOUR SALES REP IF INCOMING PRODUCT WILL BE ENTERING AT HIGHER TEMPERATURES. REFRIGERATION DESIGN IS SUBJECT TO CHANGE FOR IMPROVEMENTS. ALL DIMENSIONS ARE NOMINAL. FINAL DIMENSIONS WILL BE ±1 INCH OF DRAWING DIMENSIONS. CONTACT YOUR SALES REP IF TIGHTER TOLERANCES ARE REQUIRED.